

SÜD - WEST ANSICHT

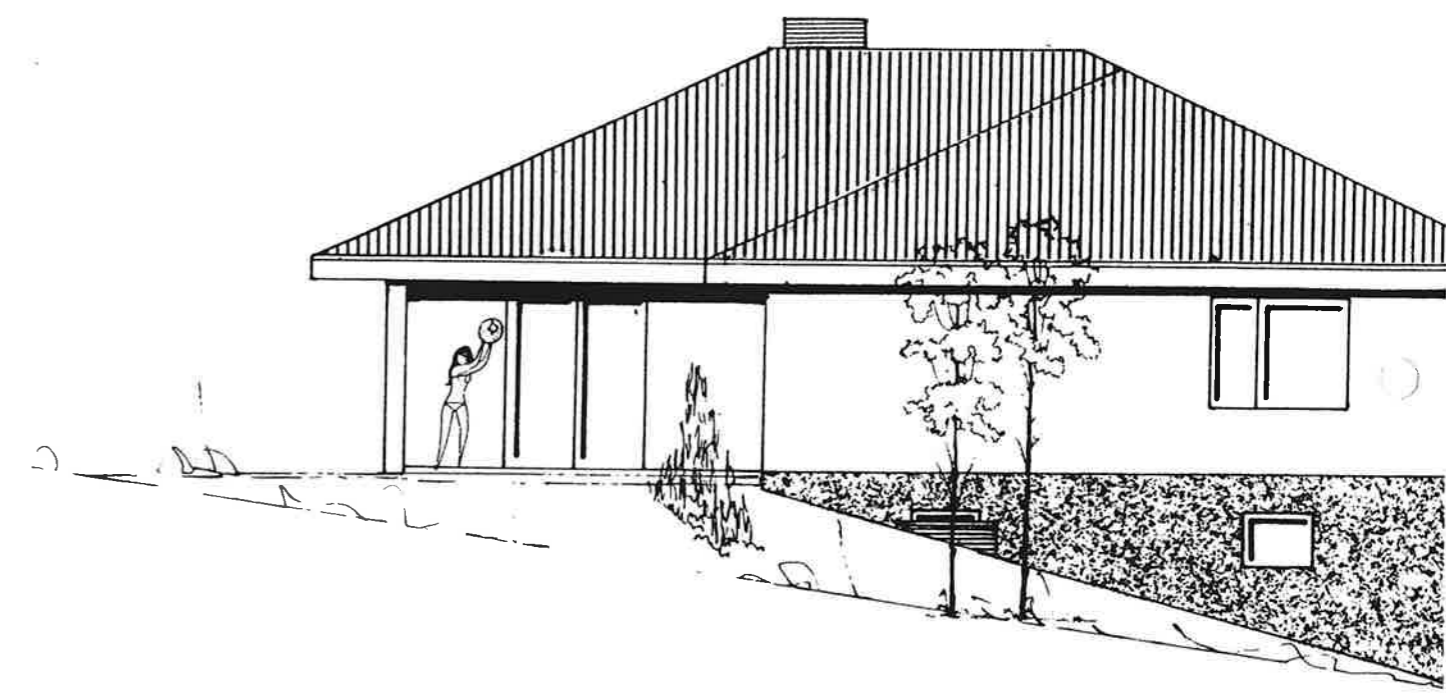

SÜD - OST ANSICHT

FENSTERMASSE MAUERLICHTE
TÜRMASSE STOCKLICHTE

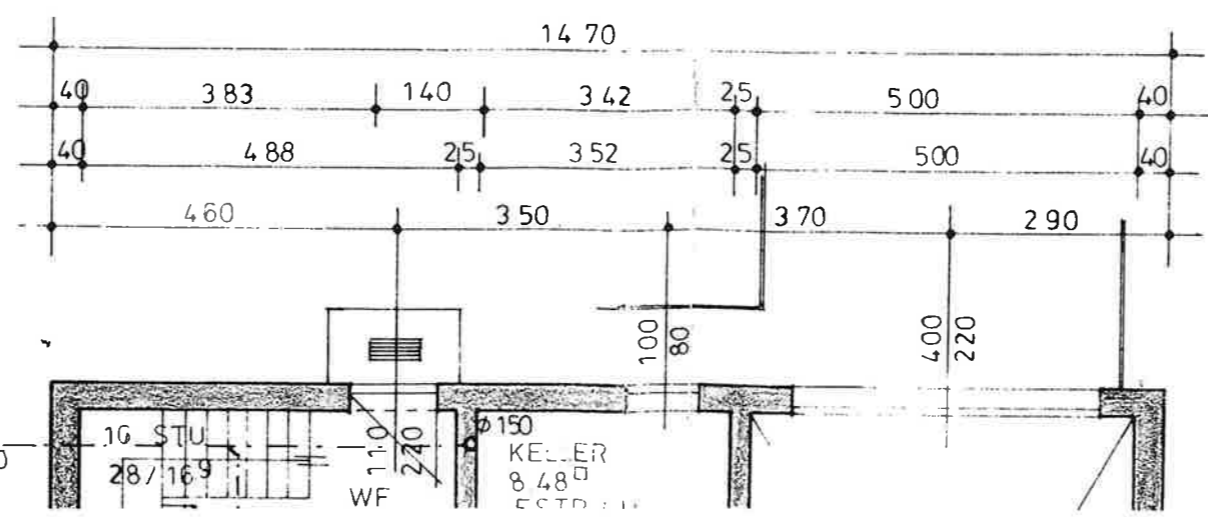

SENKGRUBE
5.0 / 3.0 / 2.0
30.00 m³

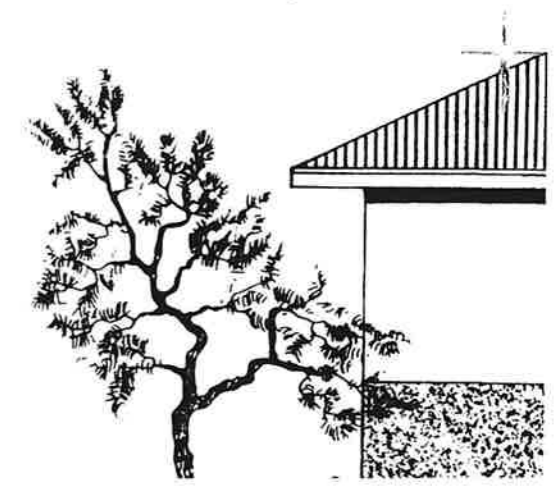
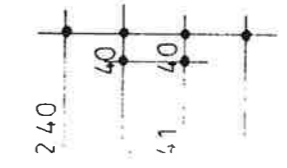
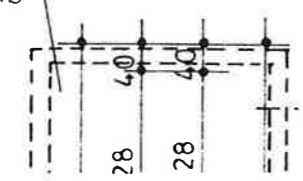
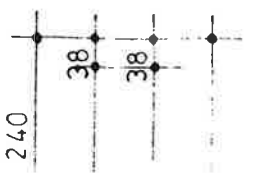

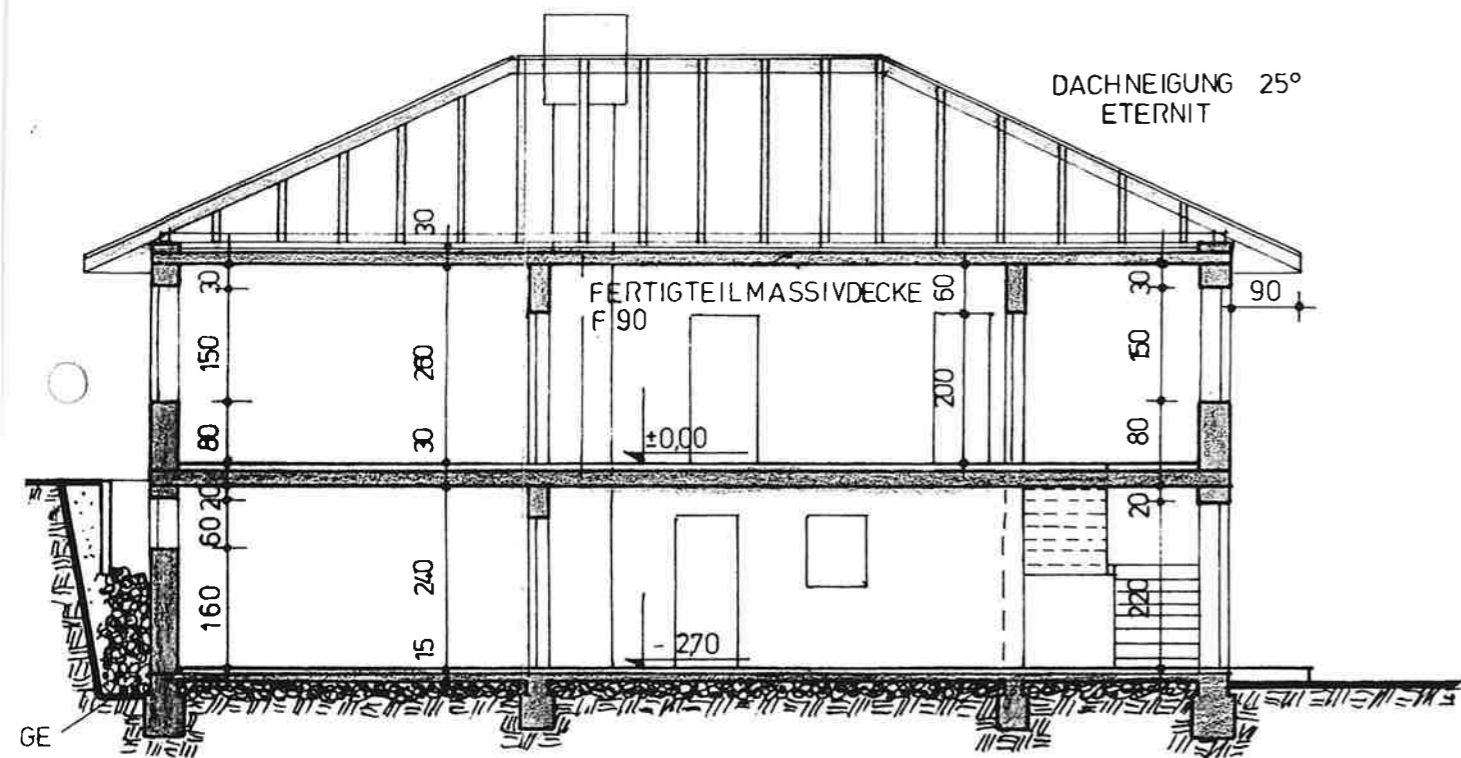

FUND. LT STATIK

SCHNITT A-B

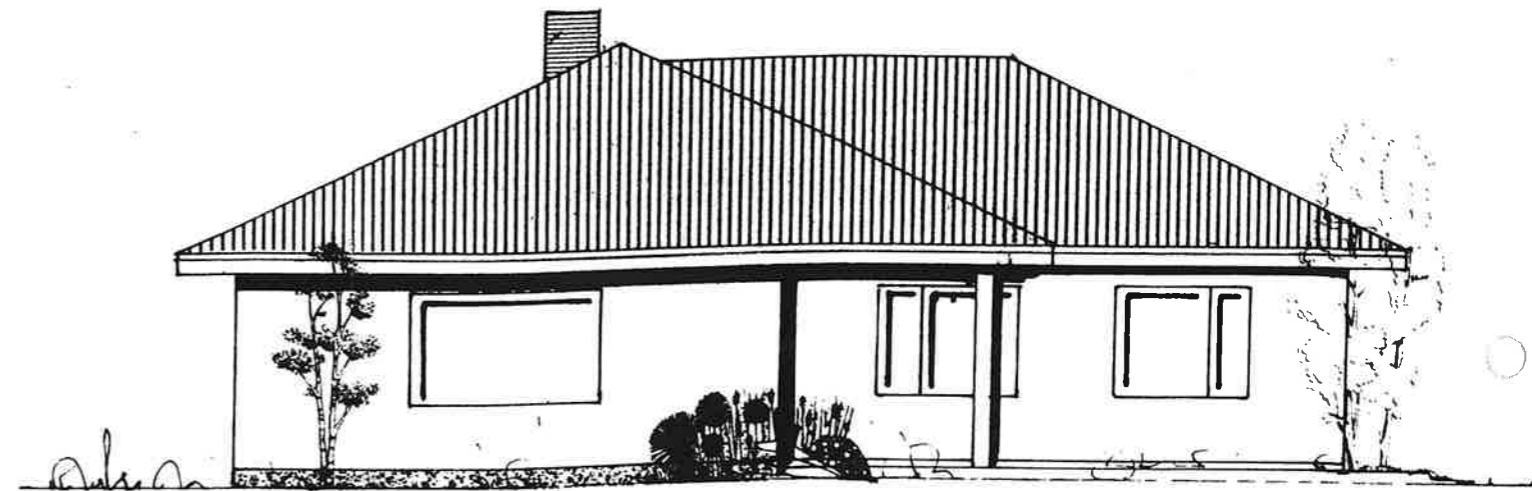

SÜD - WEST ANSICHT

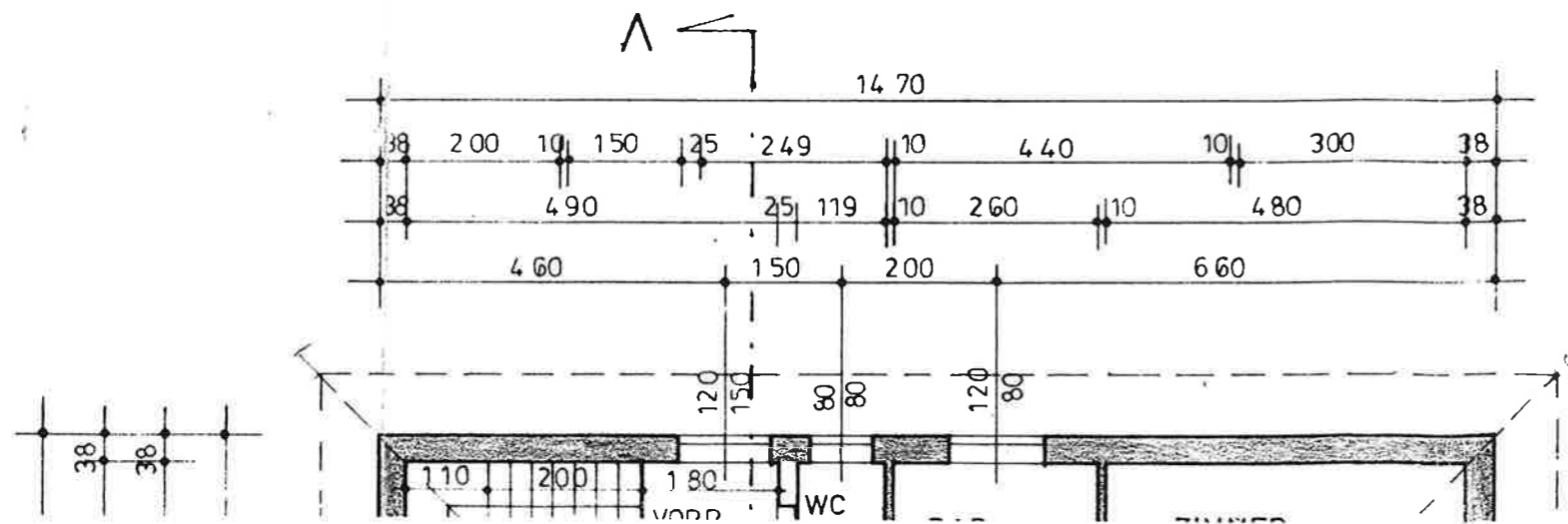

FENSTERMASSE MAUERLICHTE
 TÜRMASSE STOCKLICHTE

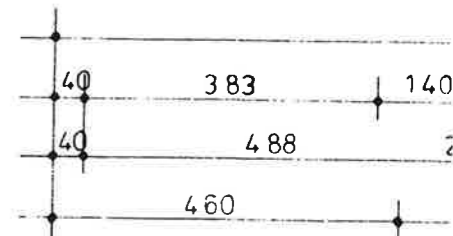

SENKGRUBE
 50/3.0/2.0
 30.00 m³

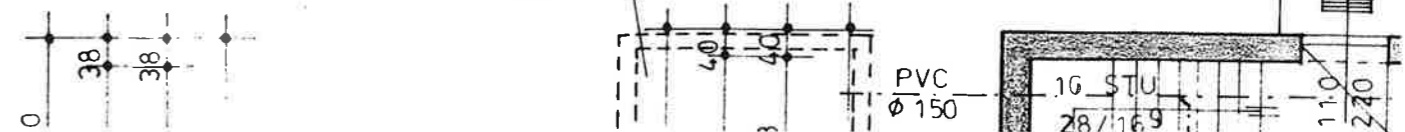

7.50

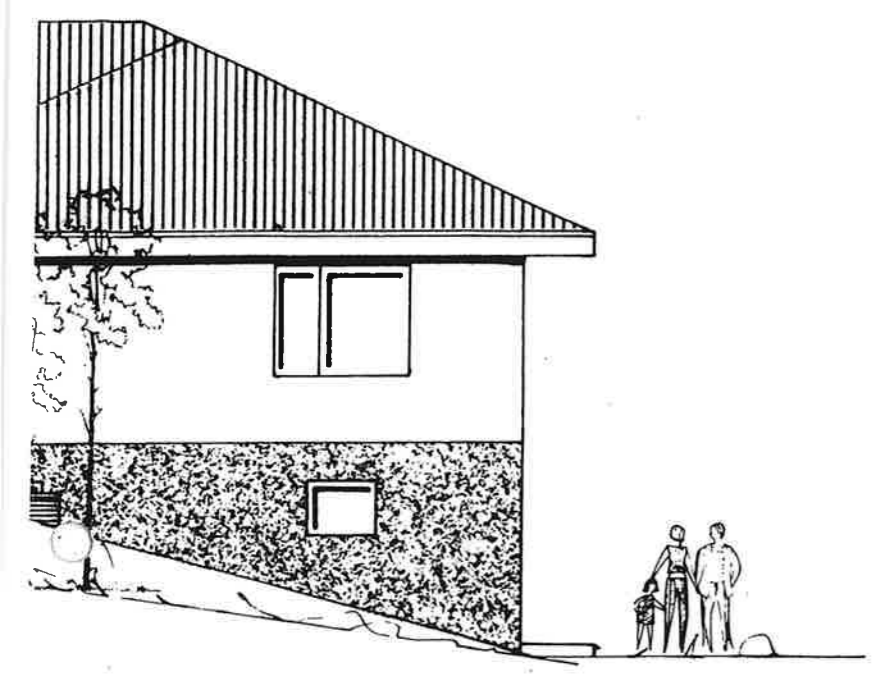

NSICHT

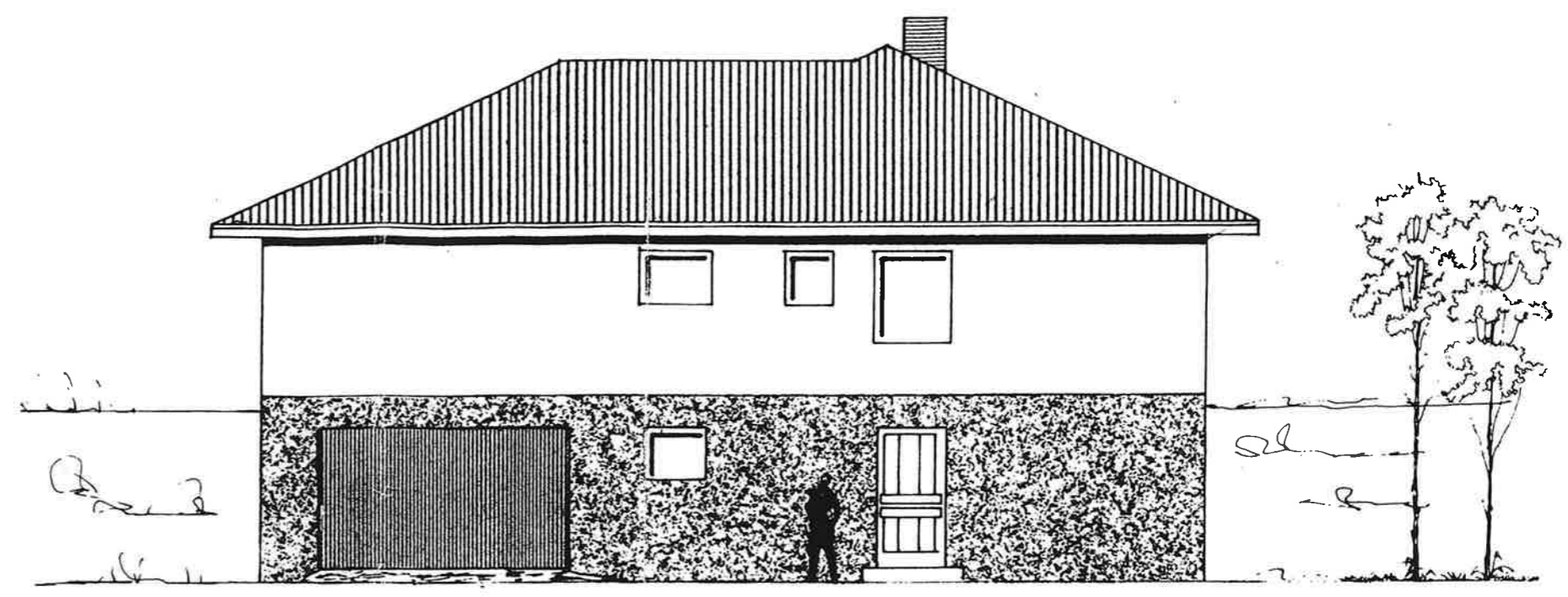

NORD - OST ANSICHT

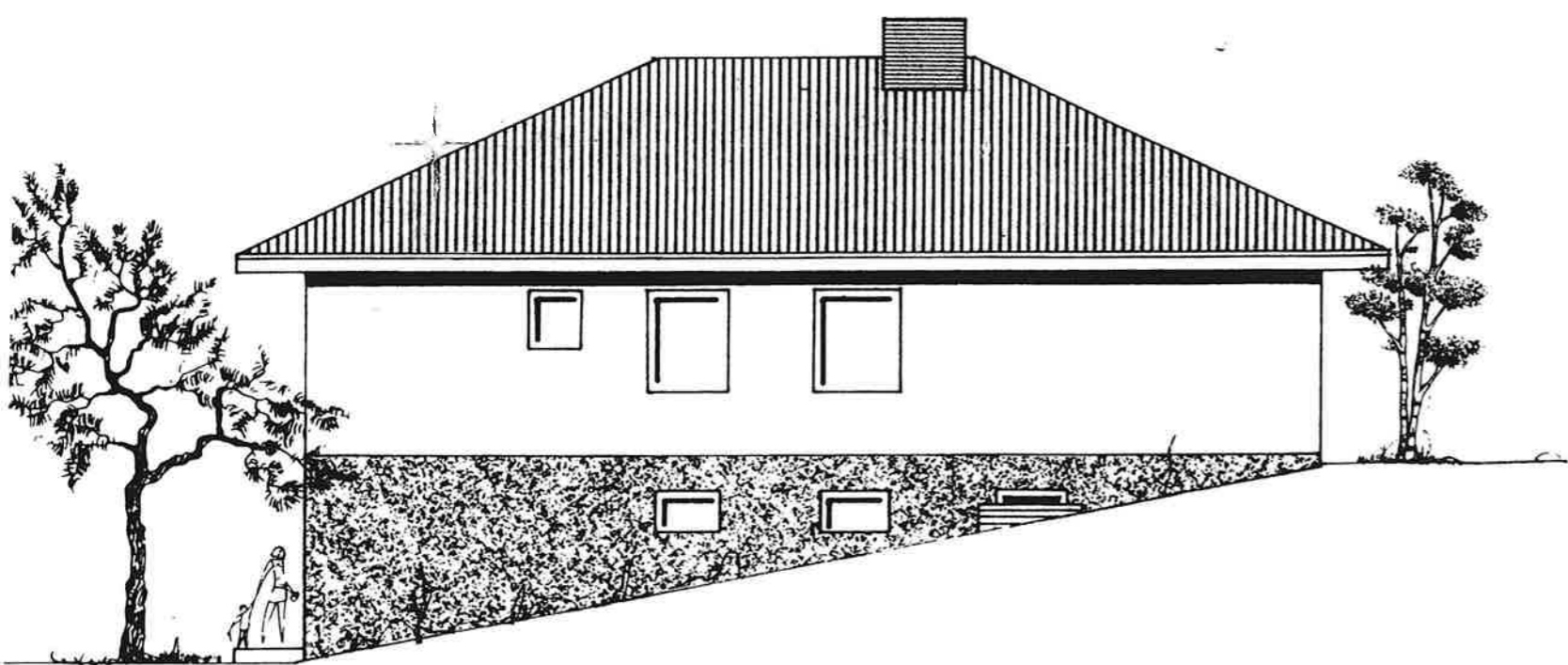

PLAN 1 : 10

ZUR ERRICHTUNG EINES WO
HAUSES AUF GR. PZ. NR. 547
DER KG. UNTERWEITERSDORF

